



GreenLine

- Submersible Agitators/Mixers
- Submersible Manure Pumps



GreenLine Submersible Pumps

The introduction of the submersible pumps brings together a new level of quality to the industry. DariTech has designed the submersible pumps for easy installation and field service. Built with heavy galvanized mounting hardware, along with replaceable wear parts.



Submersible Manure Pump

- Pump shaft made from 1050 transmission steel
- Steel molded body
- Special alloy molded fan blades for improved life and durability
- Special cutter knives for long fibers at the pump inlet
- Safety sensors built into the submersible motor for leakage and overheating protection
- Stainless steel bolts



GP - 30/40

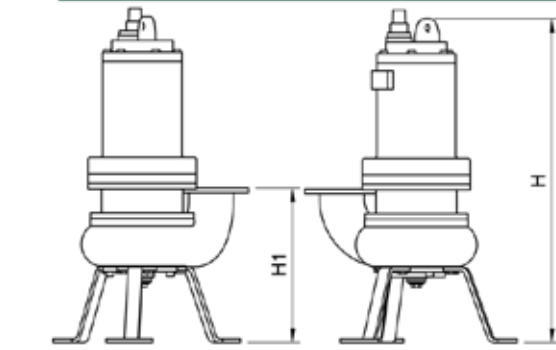

Performance Diagram

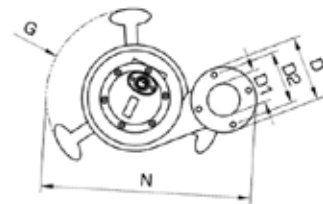
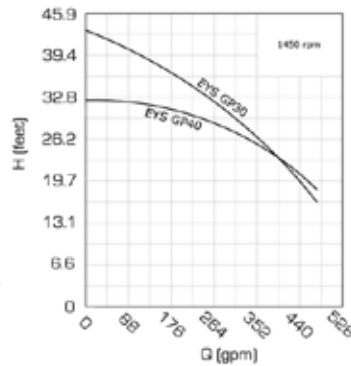

Dimensions

Model	HP	H	H1	G	N	D	D1	D2
GP-30	4	27.6	13	17.1	20.5	6.3	3.2	5.1
GP-40	5							

GP - 55

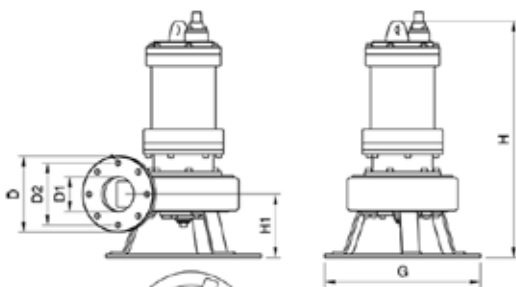

Performance Diagram

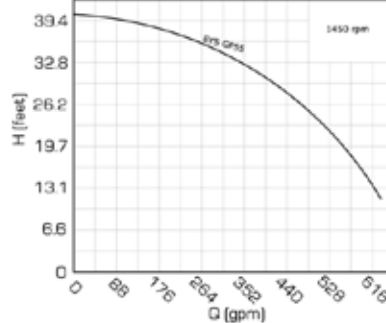

Dimensions

Model	HP	H	H1	G	N	D	D1	D2
GP 55	7.5	26.9	7.3	17.7	21.7	8.7	3.9	7.1



Advantages:

- Best solution for pumping manure from deep pits
- Economical pumping solution
- Direct powering of fan blades from the motor shaft, for minimum mechanical losses and high pumping efficiency
- Reduced risk of problems with long fibers in the pit, due to efficient cutter knives at the pump inlet
- Built in dual voltage cord
- Replaceable wear parts

GP-75/110

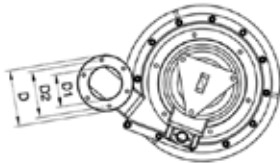
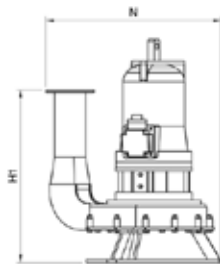
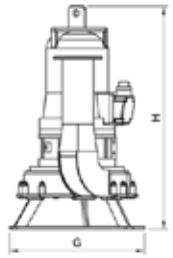

Performance Diagram

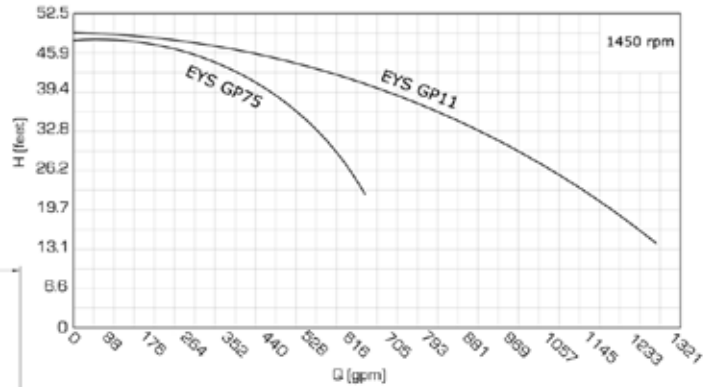

Dimensions

Model	HP	H	H1	G	N	D	D1	D2
GP-75	10	32.7	25.2	19.7	25.6	7.1	4.1	5.9
GP-110	15							



GP-150/185

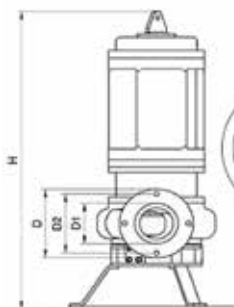
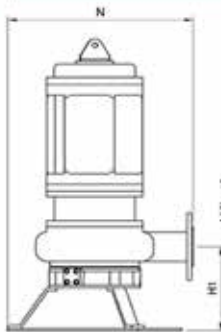

Performance Diagram

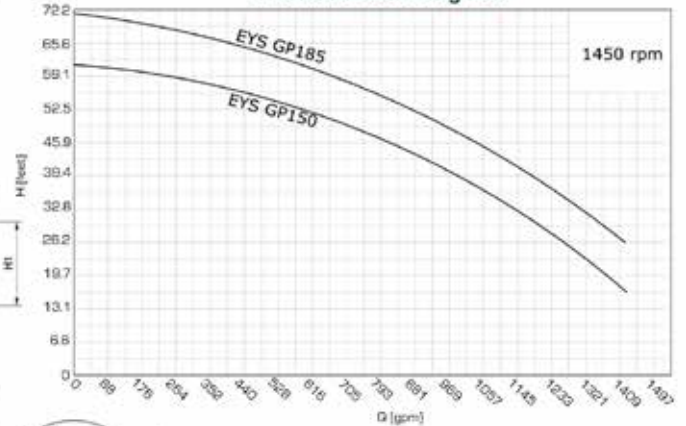

Dimensions

Model	HP	H	H1	G	N	D	D1	D2
GP-150	20	43.7	12.6	23.6	25.2	10	5.9	8.7
GP-185	25							



Submersible Agitators

Our state-of-the-art submersible agitator delivers outstanding mixing power for reception pits of all sizes and depths. It's robust design promises years of problem-free operation even under the harshest of environments.

- Transmission related power losses that are typical on vertical-shaft drive agitators are minimized.
- It delivers an impressive amount of agitation power at great efficiency thanks to it's powerful 11kW inline three-phase motor and planetary gear module.
- Equipped with thermal circuit breaker to protect from overheating under extreme conditions.
- Special body design with increased surface area for maximum dissipation.
- Electrical lift for effortless vertical positioning at various depths, for ease of servicing.
- Vertical angular positioning to target either the settled solids or the floating crust.
- Horizontal positioning around the vertical-axis (left/right) to target various directions within the pit.
- Propeller can turn in either direction for pushing or pulling action.
- Built in dual voltage cord.

Model	Output HP
DK 75	10
DK 11	15
DK 150	20
DK 185	25

